

Static Discharge Grounding Reels SDR25-0

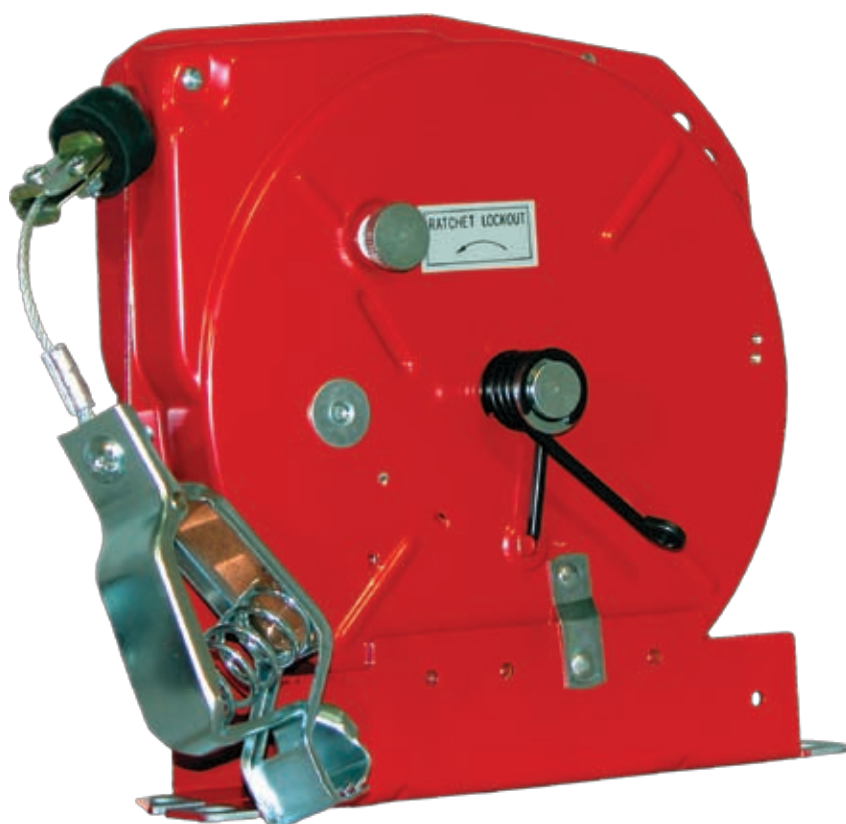

CONDUCTIX
wampfler
© DELACHAUX GROUP

CONDUCTIX INCORPORATED

The technical data and images which appear in this manual are for informational purposes only. **NO WARRANTIES, EXPRESS OR IMPLIED, INCLUDING WARRANTIES OF MERCHANTABILITY OR FITNESS FOR A PARTICULAR PURPOSE, ARE CREATED BY THE DESCRIPTIONS AND DEPICTIONS OF THE PRODUCTS SHOWN IN THIS MANUAL.** Conductix makes no warranty (and assumes no liability) as to function of equipment or operation of systems built according to customer design or of the ability of any of its products to interface, operate or function with any portions of customer systems not provided by Conductix.

Seller agrees to repair or exchange the goods sold hereunder necessitated by reason of defective workmanship and material discovered and reported to Seller within one year after shipment of such goods to Buyer.

Except where the nature of the defect is such that it is appropriate, in Seller's judgment, to effect repairs on site, Seller's obligation hereunder to remedy defects shall be limited to repairing or replacing (at Seller's option) FOB point of original shipment by Seller, any part returned to Seller at the risk and cost of Buyer. Defective parts replaced by Seller shall become the property of Seller.

Seller shall only be obligated to make such repair or replacement if the goods have been used by Buyer only in service recommended by Seller and altered only as authorized by Seller. Seller is not responsible for defects which arise from improper installation, neglect, or improper use or from normal wear and tear.

Additionally, Seller's obligation shall be limited by the manufacturer's warranty (and is not further warranted by Seller) for all parts procured from others according to published data, specifications or performance information not designed by or for Seller.

Seller further agrees to replace or at Seller's option to provide a refund of the sales price of any goods that do not conform to applicable specifications or which differ from that agreed to be supplied which non-conformity is discovered and forthwith reported to Seller within thirty (30) days after shipment to the Buyer. Seller's obligation to replace or refund the purchase price for non-conforming goods shall arise once Buyer returns such goods FOB point of original shipment by Seller at the risk and cost of Buyer. Goods replaced by Seller shall become the property of Seller.

There is no guarantee or warranty as to anything made or sold by Seller, or any services performed, except as to title and freedom from encumbrances and, except as herein expressly stated and particularly, and without limiting the foregoing, **there is no guarantee or warranty, express or implied, of merchantability or of fitness for any particular purpose or against claim of infringement or the like.**

Seller makes no warranty (and assumes no liability) as to function of equipment or operation of systems built to Buyer's design or of the ability of any goods to interface, operate or function with any portions of Buyer's system not provided by Seller.

Seller's liability on any claim, whether in contract, tort (including negligence), or otherwise, for any loss or damage arising out of, connected with, or resulting from the manufacture, sale, delivery, resale, repair, replacement or use of any products or services shall in no case exceed the price paid for the product or services or any part thereof which give rise to the claim. In no event shall Seller be liable for consequential, special, incidental or other damages, nor shall Seller be liable in respect of personal injury or damage to property not the subject matter hereof unless attributable to gross misconduct of Seller, which shall mean an act or omission by Seller demonstrating reckless disregard of the foreseeable consequences thereof.

Seller is not responsible for incorrect choice of models or where products are used in excess of their rated and recommended capacities and design functions or under abnormal conditions. Seller assumes no liability for loss of time, damage or injuries to property or persons resulting from the use of Seller's products. Buyer shall hold Seller harmless from all liability, claims, suits and expenses in connection with loss or damage resulting from operation of products or utilization of services, respectively, of Seller and shall defend any suit or action which might arise there from in Buyer's name - provided that Seller shall have the right to elect to defend any such suit or action for the account of Buyer. The foregoing shall be the exclusive remedies of the Buyer and all persons and entitles claiming through the Buyer.

INSTALLATION INSTRUCTIONS

Conductix-Wampfler Discharge Grounding Reels are used to ground static charges on service equipment during the transfer of combustible fuel and other flammable liquids. SDR reels are spring operated automatic retrieve reels containing stranded steel aircraft cable.

The reel is compact in design, for convenient mounting on fuel equipment, and provides a light, constant spring tension on the ground cable, keeping the cable from becoming tangled.

The reels are constructed of steel and are equipped with a 100-ampere ground clamp and rubber covered bumper. An instant-acting lock and release provides operator convenience.

Care must be taken when reeling cable back onto the reel. DO NOT let go of the cable - walk it back towards reel keeping tension on cable at all times.

INSTALLATION - Mount the reel securely, Pull the grounding cable out to determine if the tension is sufficient for the intended use, If additional tension is needed, apply wrench to flats on the mainspring shaft (A), rotating counter-clockwise until the desired tension is reached.

If mainspring tension is too high, it may be decreased by depressing tension lock spring (B) on opposite side of reel. Do not remove more tension than desired. If too much tension is removed, increase tension as described above.

MAINTENANCE - Servicing the Model SDR Static Discharge Reel is an easy process. Be sure the unit is mounted securely. Inspect the cable often for fraying. Lubrication is not required as lubrication for the life of the reel is applied at the factory.

Static Discharge Grounding Reel SDR25-0

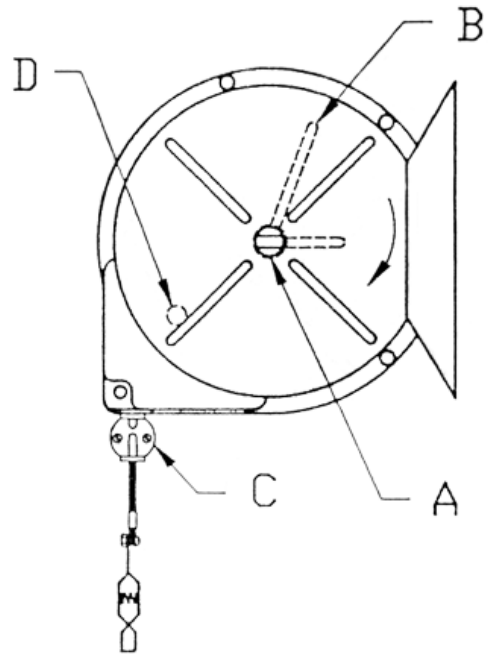

CABLE STOP - The cable stop assembly (C) may be adjusted to any position.

LOCK - The mechanical locking device works positively at all times and in any position, regardless of the cable retraction speed. The lock engages at the desired position by pulling the cable approximately 1/2 inch. The lock release knob (D) completely disengages the lock to constant tension.

GROUNDING - Care should be taken to be sure the unpainted surface of the base is properly grounded.

NOTE: DISASSEMBLY OF THIS REEL IN ANY WAY WILL VOID WARRANTY!

www.conductix.com

Conductix-Wampfler

10102 F Street
Omaha, NE 68127
USA

Customer Support
Phone: 800 521 4888
Fax: 800 780 8329

Phone: 402 339 9300
Fax: 402 339 9627

info.us@conductix.com
www.conductix.com

